

LISSÉ Monomando de bañera para montaje a pared sin juego de ducha - Cromo







LISSÉ

33 200 845



- Saliente 190-200 mm
- Chorro normal redondo
- Inversor bañera/ducha
- Salida ducha de 3/8"
- Rosetas corredizas Ø 60 mm
- Racor 1/2"
- Calibración 150 mm ± 15 mm
- Caudal máx. 13,5 l/min con 3 bares de presión hidráulica

Protección contra reflujo.

	Cromo	33 200 845-00
	Platino cepillado	33 200 845-06
	Dark Chrome	33 200 845-19
	Negro mate	33 200 845-33
	Cromo cepillado	33 200 845-93
	Dark Platinum cepillado	33 200 845-99

33 200 845
mm [inches]



Diagrama de flujo



Certificado

IAPMO_4976 (5). LGA_9603. WRAS_2311042.

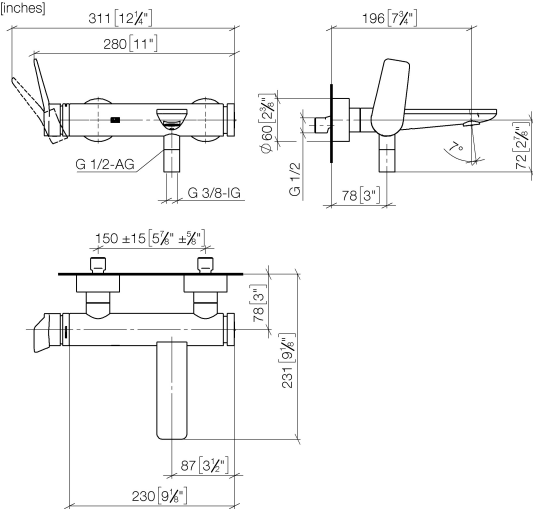
33 200 845

Piezas para otros acabados pueden encontrarse aquí:
Platino cepillado

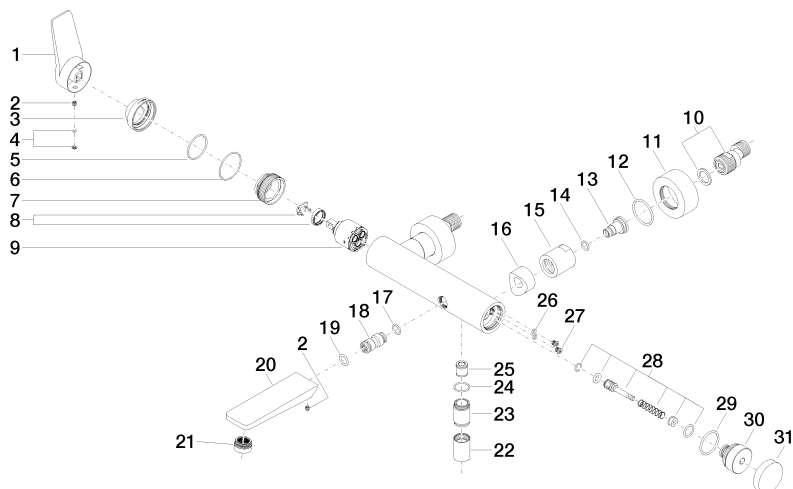

33 200 845

Lista de piezas de recambios

Nº	Número de artículo	Denominación	Cantidad de montaje	Plazo de entrega
1	09 20 84 021-00	manilla	1	10
2	90 31 11 030 00 90	varilla	2	2
3	09 28 30 032-00	funda	1	10
4	90 31 20 087 00-00	tapón	1	10
5	09 14 10 102 90	sello	1	2
6	09 14 10 190 90	sello	1	2
7	09 24 04 296 90	tuerca	1	2
8	90 28 10 148 00 90	accessorio	1	2
9	90 15 05 064 00 90	cartucho	1	2
10	04 11 04 030 00 90	racor	2	2
11	09 27 62 004-00	roseta	2	10
12	09 14 10 119 90	sello	2	2
13	09 29 05 005 20 90	boquilla	2	60
14	09 14 10 008 90	sello	2	2
15	09 23 10 048-00	tuerca	2	10
16	09 18 40 059-00	camisa	2	10
17	09 14 10 003 90	sello	1	2
18	09 24 04 043 90	boquilla	1	2
19	90 14 10 011 00 90	sello	1	2
20	09 11 84 012-00	caño	1	10
21	90 23 01 161 00-00	mezclador de aire	1	10
22	90 21 02 069 00-00	funda	1	10
23	09 24 03 115 20-00	boquilla	1	10
24	90 14 10 032 00 90	sello	1	2
25	90 23 01 141 00 90	inhibidor de reflujo	1	2
26	09 14 10 001 90	sello	2	2
27	09 30 30 113 20 90	tornillo	2	2
28	90 31 09 032 00-00	inversor	1	10
29	09 14 10 101 90	sello	1	2
30	09 21 10 035 20-00	boquilla	1	10
31	09 20 62 031-00	manilla	1	10